

TAKSTAR® 得胜

MX630 DTG

网络直播专业声卡 USB Audio Interface



使用手册 User Manual

中文目录	2-24
Contents	25-52
前言	2
产品简介	2
产品特性	2
包装清单	3
系统要求	3
适用范围	3
技术参数	4
功能示意	5
前面板	5
主面板	7
后面板	9
连接示意	11
驱动下载与安装	12
控制面板	12
驱动图标	12
声卡设置	12
播放设置说明	15
多应用程序支持	16
系统音频设置	16
系统音源	16
伴奏音源	16
ASIO输入音源5/6	16
录音应用	18
直播应用	20
IOS兼容模式	20
故障排除	21
安全警示	22
关于图标含义解释	23
关于本说明书	24
环保说明	25

■ 前言

尊敬的用户：

感谢您选购得胜MX630OTG网络直播专业声卡，为了您能够更好的了解及使用本产品，建议在使用前仔细阅读本说明书。

若存在有疑问或者您有宝贵的建议，可通过拨打得胜官方服务热线400 6828 333或微信扫描二维码关注得胜官方公众号与我们联系。



■ 产品简介

MX630OTG是一款4进4出的USB网络直播专业声卡，针对电脑及智能手机而设计，采用ASIO2.0驱动，超低延迟，支持24bit/96KHz高精度采样，兼容Windows XP/Vista/7/8/10操作系统，可加载各种专业机架进行网络直播、网络K歌及专业录音等。

■ 产品特性

- 专为娱乐直播、带货直播、网络K歌及专业录音而设计，兼容Windows10及以下操作系统
- 驱动通过了“WHQL微软认证”，确保声卡与微软系统之间的稳定性、兼容性
- 采用USB2.0数据传输标准，高速传输、超低延迟
- 支持24bit/96KHz高精度采样，录音采集、声音回放更清晰
- 采用ASIO2.0驱动标准，可同时运行两个以上VST机架实现网络直播及专业录音
- 强大的外放、内录功能，支持连麦直播，多人聊天直播不卡麦
- 支持MME、WDM及DirectSound，轻松实现声卡与电脑之间的声音信号传输
- 具有麦克风、耳机、音箱输出、手机录音等多种音量控制调节
- 配备两个混合式麦克风、乐器输入接口，可分别连接麦克风及乐器设备
- 具备OTG功能，可通过OTG接口与手机连接实现高清无损的录音、直播
- 具有两个左右声道 ϕ 6.3 mm TRS平衡输出接口，可连接有源音箱

■ 包装清单

MX630OTG声卡.....	1台
音频线（规格：Φ3mm*1.2m）.....	2条
Type-C数据线（规格：Φ4mm*1.5m）.....	1条
电源适配器.....	1个
3.5mm转6.3mm转接头.....	2个
说明书.....	1份

■ 系统要求

USB数字接口兼容Windows XP/Vista/7/8/10

Φ3.5mm接口兼容iOS、Android

计算机最低要求：AMD/intel CPU 2核2GHZ以上 内存4G

■ 适用范围

娱乐直播、带货直播、网络K歌及专业录音

■ 技术参数

话筒/线路输入1-2

频率响应: 20Hz-20KHz (± 1 dB)
动态范围: 80dB (A-加权)
信噪比: 75dB (A-加权)
总谐波失真加噪声: $<0.025\%$ (-72dB)
交调失真: -77dB@1KHz
输入阻抗: inst in, 6.8K Ω , 典型
麦克风输入: 6.8K Ω , 典型
可调增益: >50 dB
总增益范围: +54dB

耳机输出1-2

频率响应: 20Hz-20KHz(± 1 dB)
动态范围: 99dB (A-加权)
信噪比: 103dB (A-加权)
总谐波失真加噪声: $<0.0056\%$ (-85 dB)
交调失真: -75dB @ 1KHz
功率: 90mW/100 Ω
输出阻抗: 75 Ω
负载阻抗: 32-600 Ω

接口详情

手机接口: $\Phi 3.5$ mm
伴奏接口: $\Phi 3.5$ mm
麦克风接口1: XLR+ $\Phi 6.35$ mm
麦克风接口2: XLR+ $\Phi 6.35$ mm
耳机接口1: $\Phi 6.35$ mm
耳机接口2: $\Phi 6.35$ mm
音箱接口: $\Phi 6.35$ mm(L+R)
电源接口: DC 12V \equiv 1A
数据接口: USB 2.0
OTG接口: Type-C

注: 以上数据由得胜实验室测试得到, 并拥有最终解释权!

线路/伴奏输入3-4

频率响应: 20Hz-20KHz(± 1 dB)
信噪比: 100dB (A-加权)
总谐波失真加噪声: $<0.0031\%$ (-90dB)
动态范围: 97dB (A-加权)
最大输入电平: +0dB 增益: 0dB

线路输出L/R

频率响应: 20Hz-20KHz(± 1 dB)
动态范围: 98dB (A-加权)
信噪比: 102dB (A-加权)
总谐波失真加噪声: $<0.0125\%$ (-78 dB)
交调失真: -65dB @ 1KHz
输出阻抗: 75 Ω
负载阻抗: 32-600 Ω
最大输出电平: +1.2 dBV

综合参数

数据传输: USB2.0
采样率: 44.1-96KHz/24bit
电源规格: DC 12V \equiv 1A (外部电源供电)
工作温度范围: 0-40 $^{\circ}$ C
产品尺寸: 140*140*33.5mm(长*宽*高)
净重: 约465g

■ 功能示意

前面板

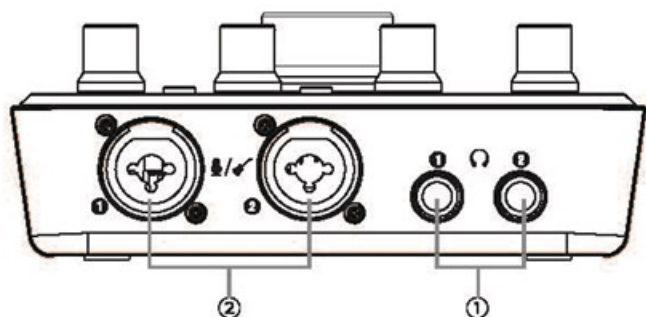

① 立体声 Φ 6.35mm耳机接口①/②:

用于连接耳机，耳机输出接口通过两个独立的驱动电路给两个耳机输出，以完美匹配 (Φ 6.35mm) 或转接 (Φ 3.5mm) 耳机。

② 麦克风/乐器接口①/②:

用于连接麦克风或吉他、电钢琴等乐器，该插口即可连接XLR型插头又可连接 Φ 6.35mm插头（平衡/非平衡），将麦克风、吉他或其他信号源连接到其中一个输入插孔。

有三种类型的输入接口连接：平衡卡侬XLR，平衡TRS 和非平衡TS。平衡信号提供更好的噪声抑制，是首选用法，尤其是使用长度超过6米的电缆时。当连接的设备需要48V幻象供电时，请使用平衡卡侬XLR。

根据标准，它们的接线如下，由AES（音频工程协会）指定：

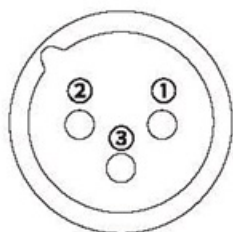

极性：①接地、②热(+)、③冷(-)

平衡XLR (卡侬)

①屏蔽 (接地) 引脚、②热 (+) 引脚、③冷 (-) 引脚

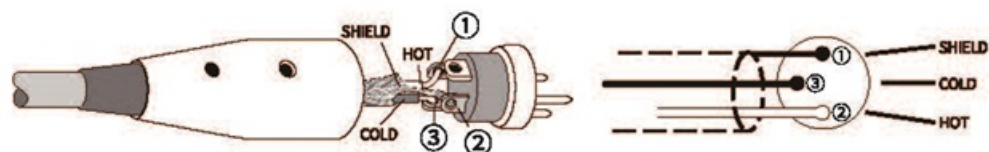

平衡卡侬插头

平衡TRS (Φ6.35mm)

热 (+) 尖端、冷环、屏蔽 (接地) 套管

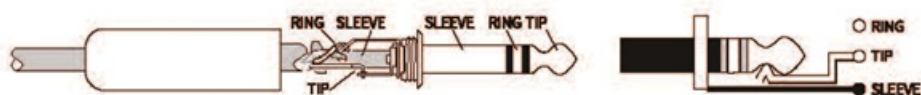

平衡TRS插头

非平衡TS (Φ6.35mm)

热 (+) 尖端、屏蔽套管



非平衡TS插头

主面板

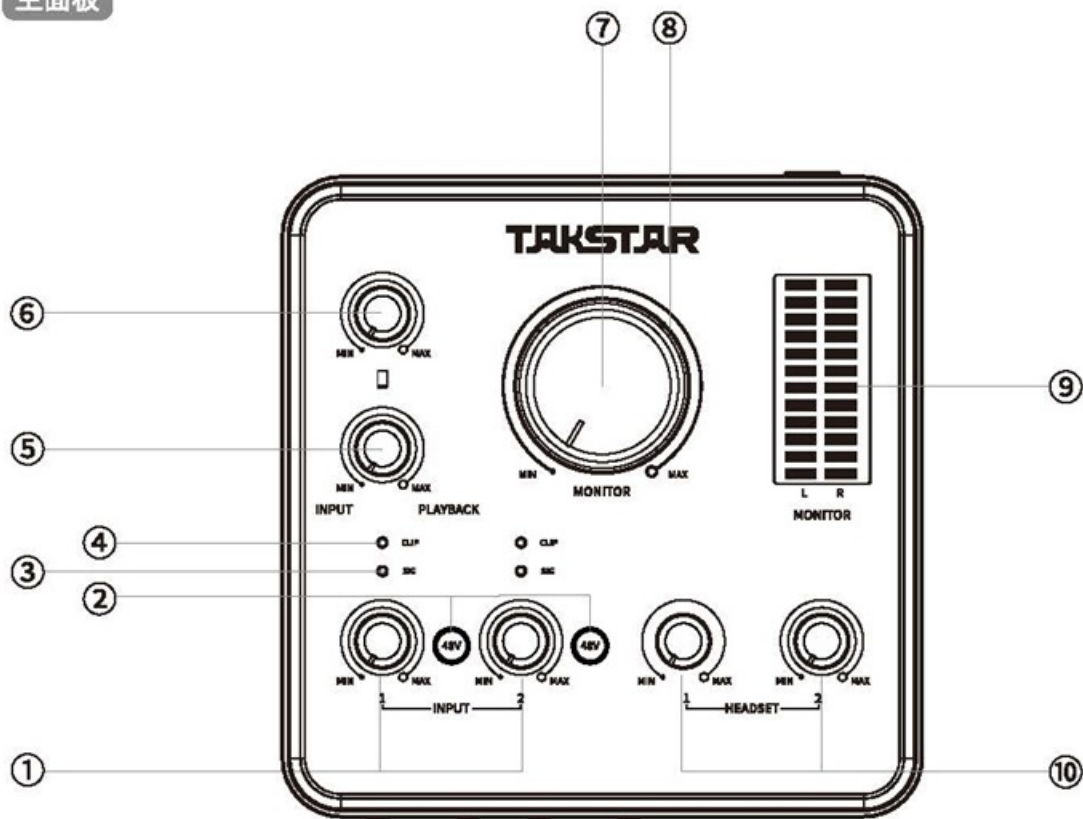

① INPUT1/2旋钮：

分别调节1/2输入接口的电平信号大小，逆时针旋转时减小输入信号电平，顺时针旋转时增大输入信号电平。

② 长按开启或关闭48V幻象电源。开启时，按键指示灯亮蓝灯；关闭时，按键指示灯熄灭。幻象电源在不需要时请关闭，在幻象电源打开时，请勿连接或断开任何设备。打开或关闭幻象电源时，应将所有音量调至最小，以防止出现噪音或导致设备损坏。点按开启或取消麦克风静音。开启时，按键指示灯亮红灯；关闭时，按键指示灯恢复蓝色。

③ SIG指示灯：

用于指示MIC插口【1】 / 【2】是否有输入信号，当检测到有信号输入时，SIG指示灯绿灯亮起，没有信号输入时，SIG指示灯熄灭。

④ CLIP指示灯：

用于指示MIC插口【1】 / 【2】的输入信号是否过载（削波），当输入信号过载时，CLIP指示灯亮红灯，当输入信号正常时，CLIP指示灯熄灭。

⑤ 软硬件监听旋钮：

调节软件和硬件声音的混合比例，将人声与设备中播放的伴奏更自由的融合。调节软硬件监听旋钮只影响耳机监听的声音，不影响录制到的声音大小。

(1) 逆时针旋转时，监听到的硬件声音逐渐增大，软件声音逐渐减小，调“INPUT”位置时，直接返听硬件输入的声音；

(2) 顺时针旋转时，监听到的软件声音逐渐增大，硬件声音逐渐减小，调至“PLAYBACK”位置时，会听到电脑或其它软件中播放的声音。

我们以录制带有背景音乐的有声小说、课件应用为例，连接麦克风录制人声，用“酷狗音乐”播放音乐。逆时针旋转时麦克风声音逐渐增大，“酷狗音乐”声音逐渐减小，同理顺时针旋转时麦克风声音逐渐减小，“酷狗音乐”声音逐渐增大。当调到一个合适的位置时，人声与音乐音量大小合适的比例。调至“INPUT”时背景音乐监听音量为最小，调至“PLAYBACK”时，麦克风声音监听音量为最小。

⑥ 手机录音音量旋钮：

调节输出至直播手机的音量大小（即输出到网络端的声音），逆时针旋转输出音量减小，网友听到的直播声音会变小，顺时针旋转输出音量增大，网友听到的直播声音会变大；

⑦ 线性输出（音箱输出）音量旋钮：

调节控制线性输出（音箱输出）音量大小，逆时针旋转减小音量，顺时针旋转增大音量；

⑧ 电源指示灯：

接通电源时，电源指示灯亮蓝色；

⑨ 总输出信号指示灯：

左右两路各6个绿灯，3个黄灯，2个红灯，随总输出电平信号大小做动态变化，红灯亮起时说明输出信号过载，应适当减小麦克风或伴奏音量；

⑩ 耳机音量旋钮：

调节前面板耳机接口HEADSET 1/2的音量输出大小，逆时针旋转音量减小，顺时针旋转音量增大。

后面板

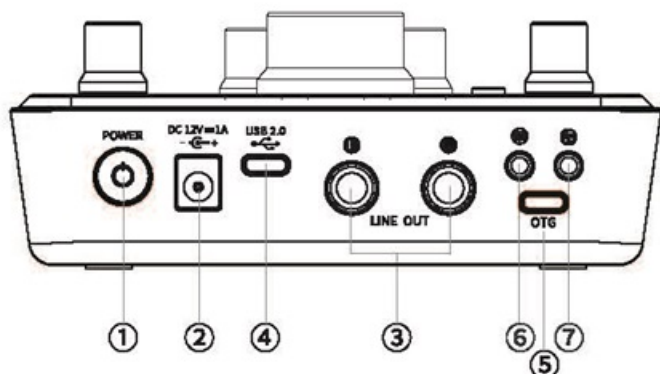

① 电源开关：

常按电源按键约2秒可开启或关闭声卡。

② 电源接口：

连接电源适配器给声卡供电，建议使用标配的电源适配器。使用非标配电源适配器时，应注意选择电源规格为：DC 12V = 1A，电源接口需满足外环为负极，内部为正极的电源适配器。

③ 线性输出（音箱输出）接口 LINE OUT L/R：

可通过 $\Phi 6.35\text{mm}$ 连接线，用于连接监听音箱或多媒体音箱。该插口可连接 $\Phi 6.35\text{mm}$ 插头（平衡/非平衡），将监听音箱与该插孔连接。

有两种类型的输入接口可供选择：平衡TRS和非平衡TS。平衡信号提供更好的噪声抑制，是首选用法，尤其是使用长度超过6米的电缆时。根据标准，它们的接线如下，由AES（音频工程协会）指定：

平衡TRS ($\Phi 6.35\text{mm}$)

热 (+) 尖端

冷环

屏蔽（接地）套管

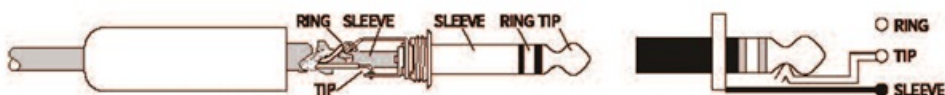

平衡TRS插头

非平衡TS (Φ6.35mm)

热 (+) 尖端

屏蔽套管

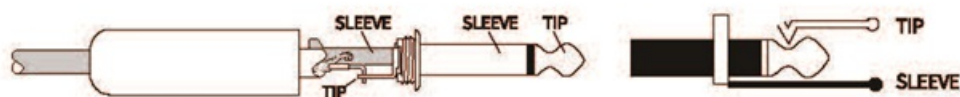

非平衡TS插头

④ USB接口:

USB2.0规格, 用于连接电脑的标准USB插口。确保通过高品质USB数据线连接 (建议使用声卡原装USB数据线), 中间没有USB延长线和USB集线器。当连接USB3.0时, 只能使用USB2.0的协议。

⑤ OTG接口:

通过OTG数据线与直播手机、平板连接实现无损录音、直播及音乐鉴赏等, 请使用高品质OTG数据线连接 (建议使用原装的OTG数据线)

⑥ 手机接口:

通过Φ3.5mm音频线连接直播手机, 可将声卡输出的声音信号传输给直播手机, 实现手机直播。

⑦ 伴奏接口:

通过Φ3.5mm音频线连接音源设备, 比如手机、播放器、CD机等, 用于直播时实现一部手机直播, 另一个音源设备播放伴奏。

■ 连接示意

前面板

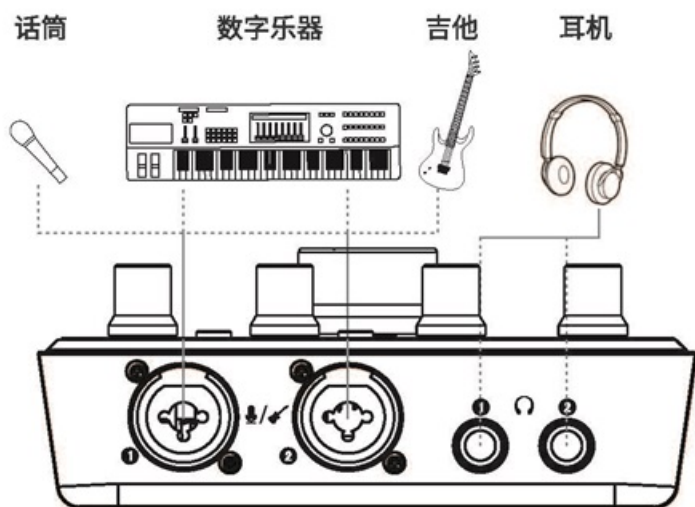

后面板

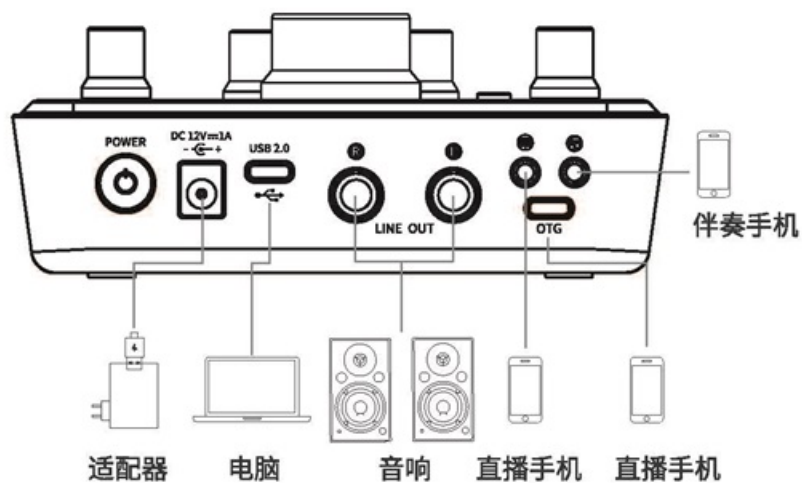

■ 驱动下载与安装

一、驱动下载

为保障良好的用户体验，我们会不断更新驱动及固件，如有需要请在得胜官方网站<https://www.takstar.com/>下载最新驱动。

下载方法1：登陆得胜官网，进入服务支持页面的下载中心，通过搜索功能搜索“MX630OTG”，找到“MX630OTG声卡驱动”进行下载；

下载方法2：登陆得胜官网，通过搜索功能搜索“MX630OTG”，进入“MX630OTG”产品详情页，在详情页的“相关下载”中找到“MX630OTG声卡驱动”进行下载。

将下载好的文件解压缩，并运行TAKSTAR_XY-S1Audio_x.x.x.setup进行驱动安装，驱动的安装、卸载及升级详情操作步骤请参阅“MX630OTG声卡操作指南”，“操作指南”可到“MX630OTG”产品详情页的“相关下载”中下载获取。

■ 驱动控制面板

一、驱动图标

驱动安装好后，MX630OTG的图标会出现在任务栏通知区，如果它们没出现，点击任务栏中的小三角来设置这些图标的显示，如下图所示：

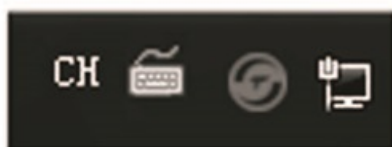

二、声卡设置

双击驱动图标，如下打开声卡驱动面板，如下图所示：



1. USB流模式

USB流模式有三个选项：最小延时、低延时、标准模式。

① 最小延时：声卡的输入延迟与输出延迟为最小，返听延迟小于10ms（取决于缓冲大小），注意此选项对电脑性能要求比较高，推荐win7/win8系统在使用过程中不要打开其它大型软件和处理其它任务，避免产生意外的杂音；

② 低延时：声卡的延迟比最小延迟要高，返听延迟>20ms；

③ 标准模式：声卡的延迟比较大，返听延迟>30ms。

2. 采样率

设置当前采样率，采样率有四个选项：44100、48000、88200、96000，根据不同的需求设置采样率。

不管选择什么采样率，音频驱动都会将采样率转换为44.1K输出到立体声混音里面去，这样保证在网络上传输的带宽占用较少，让您有一个流畅的主播体验。

因为对系统做出改变需要些时间，因此修改采样率后不能立即进行录音或播放，需要等待至少5s的时间，根据控制面板状态栏中的当前采样率的大小来判断采样率是否切换。

注意：由于微软的系统限制，当用户要对WDM设备进行配置更改时，需要通过驱动的采样率设置更改来更改所有WDM设备的采样率。在播放和录音过程中不能进行采样率更改，请在退出播放软件及机架软件后，再更改采样率，如下图所示：



3. ASIO缓冲区

ASIO缓冲区有五个选项：64、128、256、512、1024，根据不同需求设置缓冲区。

缓冲区大小可以决定ASIO和WDM进出数据的延时，对于系统稳定性也有一定影响。以毫秒为单位，显示音频输入和输出的延迟时间。音频延时因ASIO缓冲区大小设置不同而有所差异，ASIO缓冲区值设置越小，音频延时就越低。

缓冲区的选择原则：缓冲区越小延迟越低，但也容易引起缓冲丢失，根据自身电脑的性能选择一个较优的缓冲大小，缓冲区的选择和采样率、流模式有匹配关系，当不匹配时系统会有相应的提示，此时您需要适当加大缓冲，如下图所示：



ASIO不支持异步操作，这意味着输入和输出信号必须有相同的采样率，否则将会产生重复的可听噪声。

4. 音频质量

音频质量选择：当采样率选择大于48K及以上时，此选项发挥作用，决定从系统喇叭进来的声音重采样的音频质量。

5. 使用MMCSS服务

使用MMCSS服务，为ASIO驱动激活更高优先级的支持。注意：目前只有最新版Cubase/ Nuendo可以在较高负载下支持激活此选项。其他软件若启用此选项会降低性能。重启ASIO后，更改生效。由此可以很方便地检查哪种设置会工作得更好。默认开启状态，当VST机架的进程基本优先级为“实时”时，建议关闭MMCSS反而会提高录音的稳定性，因为优先级为“实时”时采用MMCSS会导致线程优先级反转导致不稳定。

■ 播放设置说明

MX630OTG支持ASIO直接监听，但应该注意，并不是所有的程序都完全支持直接监听，这会影响ADM的兼容性。MX630OTG支持MME、WDM及DirectSound，至于哪一个会更好一些，则取决于所使用的应用程序。

在所使用的音频播放软件中，必须将MX630OTG设为输出设备。一般来说，可以在播放软件的播放设备、音频设备等菜单下的选项或设置中进行这样的设置。

以“酷狗”音乐为例，截图是“酷狗音乐”设置对话框，选择一个设备后，音频数据将被送到相应的虚拟输出设备（这取决于所选择的播放设备），如下图所示：



- ① 当选择“ASIO输入音源5/6”为音频输出设备时，音频数据将输出给到机架软件里，在机架软件的输入设备中选择对应的音频通道后播放的音乐信号将被引入机架；
- ② 当选择“伴奏音源”为音频输出设备时，“酷狗”播放的音乐将会被发送到网络端，在直播或各种聊天平台中，网友将能听到您“酷狗”所播放的音乐；
- ③ 当选择“系统音源”为音频输出设备时，“酷狗”播放的音乐只能输出给自己监听，不会传送给网络端。

■ 多应用程序支持

MX630OTG支持多客户端操作，这意味着多个应用程序可以同时运行，使用多个WDM和ASIO的输入，ASIO和WDM格式甚至可以在相同播放通道内同时使用。但是，因为WDM采用实时的采样率转换(ASIO不能)，因此所有激活的ASIO机架软件只能使用相同的采样率。

■ 系统音频设置

1. 系统音源：

“系统音源 TAKSTAR MX630OTG Audio”通道，此通道声音不经过录音混音器直接输出，例如系统提示音，网页的声音及软件默认输出的声音，在网络聊天或直播时，如果选择系统音源，则播放软件上播放的音乐不会传输给网络对方，只能自己听到。

2. 伴奏音源：

“伴奏音源 TAKSTAR MX630OTG Audio”通道，可将电脑播放的声音传输给网络端，即网络聊天或直播过程中，网友和自己都能听到电脑播放的声音。

3. ASIO输入音源5/6：

“ASIO输入音源5/6 TAKSTAR MX630OTG Audio”通道，播放软件输出的音乐经过机架后再输出给网络端。如果不开启机架，网友是不能听到您播放软件所播放的音乐。

ASIO驱动安装完成后，将自动将“系统音源 TAKSTAR MX630OTG Audio”设备默认为当前播放设备，将“立体声混音 TAKSTAR MX630OTG Audio”设备默认为当前录音设备，如下图所示：



以Windows7为例，打开电脑系统喇叭的“播放设备”选项，可查看当前使用的播放设备。在“播放设备”对话框的“级别”选项中可调整相关播放设备的音量大小，如下图所示：



也可通过系统喇叭的“打开音量合成器”调节相关播放设备的输出音量大小，如下图所示：



■ 录音应用

通过录音软件进行录音时，必须选择相应的录音设备MX630OTG Analog (x+y) 或MX630OTG Virtual (x+y)；

首先参考连接示意图将声卡设备连接好，然后安装好声卡驱动，（具体驱动安装步骤请参考“操作指南”的相关内容，“操作指南”可到得胜官网www.takstar.com 产品详情页进行下载获取）；

以CUBASE为例，在机架的音频系统的ASIO设置里选择“TAKSTAR MX630OTG ASIO Driver”作为默认的录音设备，如下图所示：

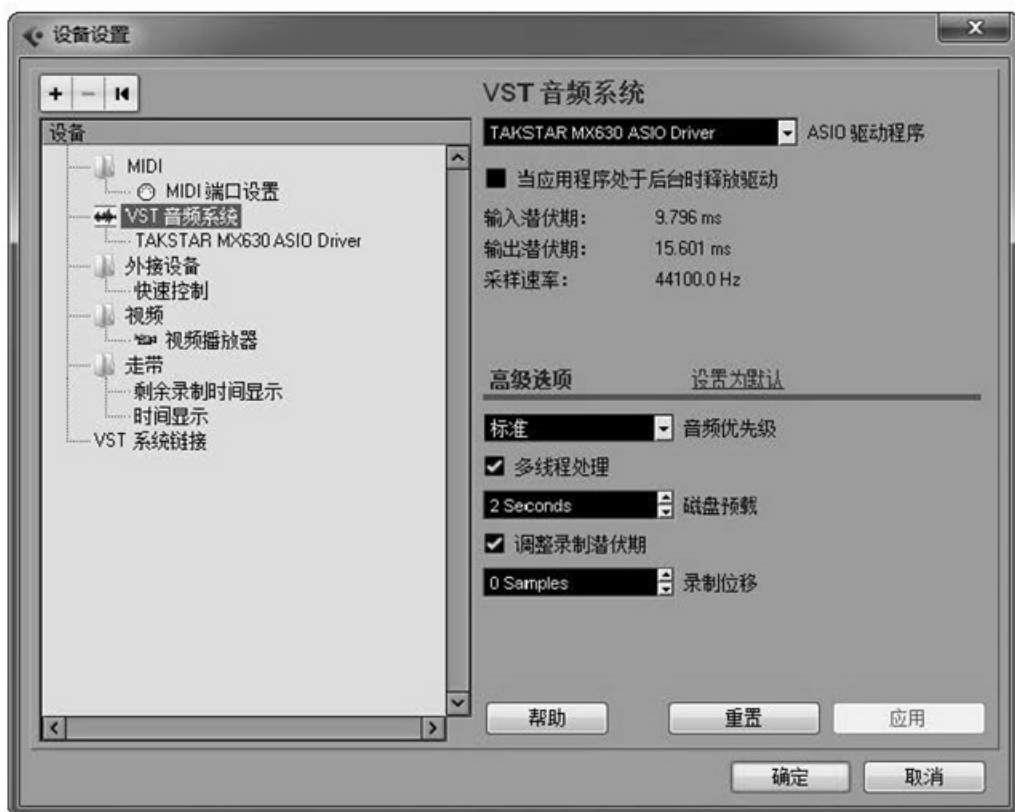

在不同录音轨道的设备端口选择对应的输入设备，当选择MX630OTG Analog inp (1+2) 时，对应麦克风输入1/2的通道信号，当选择MX630OTG Analog input(3+4)时，对应声卡的伴奏输入接口信号，当选择MX630OTG Virtual input(5+6)时，对应播放器的ASIO输入音源5/6信号，即将播放信号引入机架。不同的录音软件设备端口命名有所差异，以实际应用的录音软件为准，如下图所示：

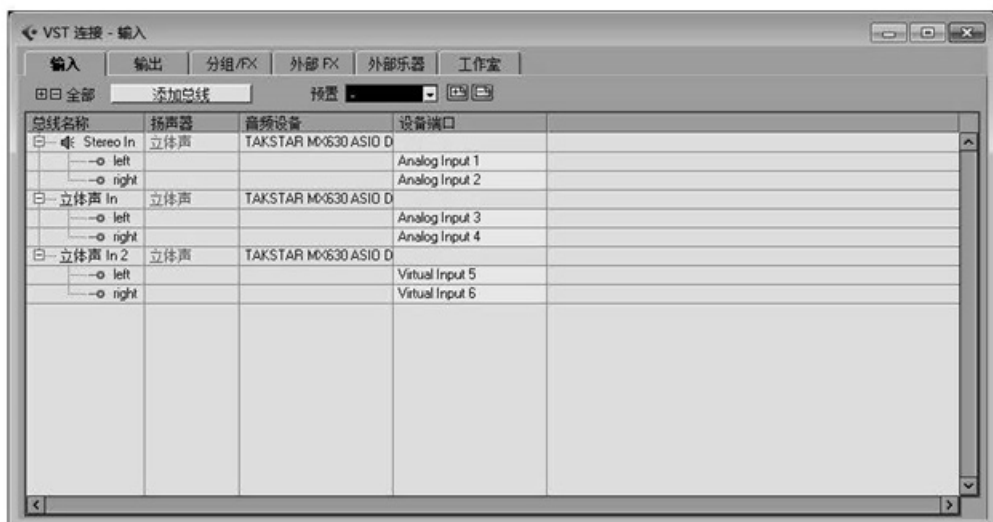

在不同录音轨道的设备端口选择对应的输出设备，选择MX630OTG Analog output(1+2)时，对应输出（音箱输出）接口L/R及耳机输出1/2接口信号，如下图所示：

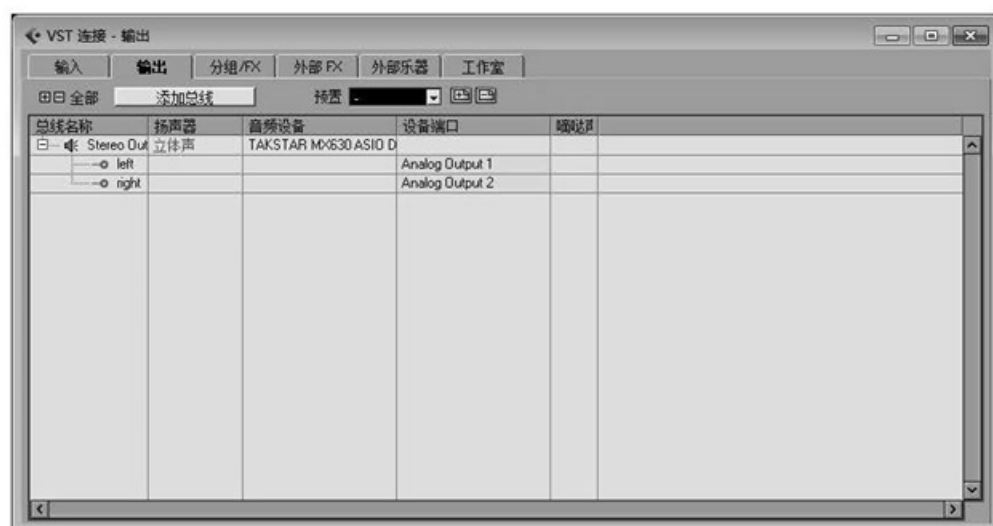

更多录音使用的方法建议参考录音软件使用帮助或到该录音软件相应的官方网站获取该软件的学习资料。

■ 直播应用

参考连接示意图安装连接好设备后，软硬件监听旋钮调至“PLAYBACK”方向，打开播放软件，如“酷狗音乐”选择“伴奏音源”为输出音频设备，参考录音应用部分进行机架的设置及机架插件的效果处理（要掌握效果插件的处理调节方法及应用技巧您需要学习了解录音相关的混音技术知识），然后在电脑端及手机端打开相应直播平台即可进行电脑手机同步直播了。

■ OTG功能

MX6300TG声卡可直接通过OTG接口与手机连接实现高清无损录音、直播、音乐鉴赏等操作。

如果iOS系统版本过低，可能会出现不兼容的情况，具体要看iOS系统版本而定。在较新版本的iOS中，连接后会显示设备名称，如果出现声卡与所接iPad、iPhone设备出现不兼容时，此时iPad、iPhone会检测到一个不兼容的USB设备，并显示提示信息“不可使用的设备——连接的USB设备不被支持”。我们强烈建议购买苹果原装数据线，如果iPad、iPhone后面板装有保护壳，数据线的插头可能发生插不紧或接触不良的情况，如果出现这种问题，请取下保护壳。

提示：MX6300TG声卡OTG功能还可以兼容部分安卓手机及平板，由于市面上安卓手机品牌及系统版本繁多，具体有什么机型可以兼容，要视实际应用情况而定，您可以自行测试，我们不便做出推荐。

■ 故障处理

一、不能开机

确保设备通过适配器连接到电源；

二、电脑不能识别

1. 确认是否正确使用USB数据线，检查USB线缆是否断裂或损坏，尝试使用正常的USB数据线替换，不宜使用超过3米的数据线连接；
2. USB端口没有在系统中激活（请检查Windows系统的“设备管理器”）；
3. USB线缆没有连接到插孔，或没有正确连接到插孔；
4. 声卡没有连接电源；
5. 驱动是否已被正确安装。

三、没有声音

1. 检查设备音量控制旋钮是调节过小，尝试调整音量旋钮至正常电平；
2. 检查播放软件是否正常播放，尝试退出后重新打开，看是否恢复正常；
3. 检查音频设备是否处于禁用状态；
4. 软件或硬件声音没有，检查软硬件监听旋钮是否处于INPUT或PLAYBLACK位置，尝试调整后，才查看声音是否恢复；
5. 检查麦克风和音箱是否正确与设备连接，请参照连接实例确认；
6. 如果使用48V供电的电容麦克风，请检查“48V”开关指示灯是否处于亮起状态；
7. 检查耳机是否连接到位，请尝试重新插拔后再试；
8. 检查音频设备是否已选择为本设备，请参照电脑音频设置说明及播放软件音频设备选择进行确认；
9. 是否同时有其他USB设备与电脑连接，尝试拔除后在检查声音是否恢复正常；
10. 是否有其他程序在同时运行冲突，尝试关闭其他程序后检查声音是否恢复正常。

四、不正常声音（噪音、断音、失真）

1. 检查ASIO缓冲区设置是否过低，对比当前缓冲区，参考本说明书的“ASIO缓冲区”选择建议，尝试提高ASIO缓冲区后检查声音是否恢复正常；
2. 是否正在录制或播放长的连续音频，计算机的音频数据处理能力取决于许多因素，其中包括CPU速度对外接设备的访问，尝试减少音轨后检查声音；
3. 已知问题如电脑CPU供电不足或者USB总线传送速率不足，则会发生爆音或噪声。为避免发生这种问题，可在声卡的ASIO控制面板中增加缓冲区大小。

■ 安全警示

为避免电击、高温、着火、辐射、爆炸、机械危险以及使用不当等可能造成的人身伤害或财产损失，使用本产品前，请仔细阅读并遵守以下事项：

1. 使用产品时请确认所连接设备与本产品功率是否匹配以及合理调整音量大小，不要在超过产品功率及大音量下长时间使用，以免造成产品异常和听力损伤；
2. 使用中若发现有异常(如冒烟、异味等)，请立即关闭电源开关并拔掉电源插头，然后将产品送经销商检修；
3. 本产品及配件都应放置在室内干燥通风处，勿长期存放在潮湿、灰尘多的环境，使用中避免靠近火源、雨淋、进水、过度碰撞、抛掷、振动本机及覆盖通风孔，以免损坏其功能；
4. 本产品不得遭受水滴或水溅，产品上不得放置诸如花瓶类的装有液体的物品；
5. 在对本设备进行清洁时，请务必将电源插头从电源插座中拔出，清洁设备时，使用柔软的干布。请勿使用涂料稀释剂、溶剂、清洁液或浸了化学物质的抹布；
6. 在雷暴期间或长时间不使用时，请拔下本设备的插头；
7. 请勿使用墙壁插座或延长线过载，否则可能会导致风险火灾或电击；
8. 保护电源线不被踩到或挤压，尤其是插头、插座以及它们与电源线连接的位置；
9. 使用该产品时需遵守相关安全规定，法律法规明确禁止使用场合请勿使用本机，以免导致意外事故；
10. 请使用制造商指定的附件；
11. 请不要自行拆机改装或维修，以防止出现人身伤害，如有问题或服务需求请联系当地经销商跟进处理，未经同意对本设备进行自行拆机改装或维修，可能会失去由得胜电子有限公司提供的保修服务；
12. 若使用电源适配器为本产品供电，请使用配送的电源适配器；如需使用其它适配器，应购买获得CCC认证并满足标准要求的电源适配器；
13. 本产品适用海拔及气候条件由选配的适配器决定，适配器上图标代表含义如下：





仅适用于海拔2000
米以下地区使用



仅适用于非热带
气候条件下使用

■ 关于图标含义解释

 根据RL2004/108/EG和European Low Voltage Directive (欧洲低电压指令) RL2006/95/EG的测试结果表明,本产品符合欧共同体关于电磁兼容性的成员国法律整合的指令中所规定的限值。

 此符号表示,根据WEEE指令(2012/19/EU)和国家法律,由于这种类型的废弃物会有潜在的有害物质,可能对环境和人类健康产生负面影响,所以本产品不应与您的家庭垃圾一起处置,应将本产品交由授权的电气和电子设备(WEEE)回收站回收。同时,您在正确处理本产品的同时将有助于自然资源的有效利用。如需了解更多有关您可以在何处放置废物回收设备的信息,请联系您当地的城市办事处、废物管理局或家庭废物处理服务部门。

 未经合规方明确批准的变更或修改可能会使用户失去操作设备的权限。此设备符合FCC规则第15条部分的要求。操作须符合以下两个条件:

- (1) 此设备可能不会造成有害干扰,并且
- (2) 此设备必须接受接收到的任何干扰,包括可能导致意外操作的干扰。

 该图标表示产品通过了“WHQL微软徽标认证”,即“微软操作系统硬件质量实验室认证”。WHQL认证是微软公司为了保证系统的稳定性与兼容性而推出的一项基准认证制度。通过WHQL认证的产品,能与Windows操作系统之间做到更好的兼容性、稳定性、互通性,并且消除系统或设备宕机和性能下降的问题,为用户带来更好的使用体验。微软规定凡是通过WHQL认证的产品都被授予“Windows Compatible Logo”标志,其相关信息都会出现在微软官方网站和操作系统的硬件兼容列表(HCL)中,以方便查询。

经过WHQL微软徽标认证的驱动程序在安装过程中不会弹出兼容性的提醒。设备驱动包含在微软的硬件兼容性列表中,并且驱动经数字签名认可。另外用户的系统不会遭到不稳定的、性能差的驱动和软件的影响,提高产品在用户心中的信任度。

 该图标表示设备仅适合室内使用

 该图标表示产品所标配的适配器符合“中国强制性产品认证”3C认证要求。

 该图标表示设备符合二类电器双重绝缘要求。

■关于本说明书

本说明书中内容符合截止印刷之日的技术规格。由于得胜公司会不断改进产品，本说明书可能不符合您的特定产品的技术规格。要获取最新版说明书，请访问得胜官网，然后下载说明书文件。技术规格、设备或另售的附件在各个地区可能有所不同，如有问题请与当地得胜经销商确认。如需更多支持和深层产品信息，请浏览得胜官方网站：<https://www.takstar.com/>

■环保说明

产品中有毒有害物质或元素的名称及含量标识表

部件名称	有毒有害物质或元素					
	铅 (Pb)	汞 (Hg)	镉 (Cd)	六价铬 (Cr(VI))	多溴联苯 (PBB)	多溴二苯醚 (PBDE)
塑料部件	○	○	○	○	○	○
金属部件	×	○	○	○	○	○
电路板组件	×	○	○	○	○	○
线缆	×	○	○	○	○	○

本表格依据SJ/T 11364的规定编制。

○: 表示该有害物质在该部件所有均质材料中的含量均在 GB/T 26572 规定的限量要求以下。

×: 表示该有害物质至少在该部件的某一均质材料中的含量超出 GB/T 26572 规定的限量要求。

此标志为产品的环保使用期限标志，
且此环保使用期限只适用于产品正常工作的温度和湿度等条件。



Preface	26
Introduction	26
Features	26
Product Content	27
System Compatibility	27
Application	27
Specification	28
Function Description	30
Front Panel	30
Master Panel	32
Rear Panel	34
Connection Diagram	36
Driver Download and Installation	37
Driver Panel	37
A. Driver Icon	37
B. Device Setting	37
Playback Setting Description	40
Multiple Apps Support	42
System Audio Setting	42
System Audio Source	42
Accompaniment Audio Source	42
ASIO Input Sound Source 5/6	42
Recording Application	45
Webcast Application	47
OTG Function	47
Troubleshooting	48
Safety Instructions	49
Label Meanings	50
About This Manual	52

■ Preface

Dear customer,

Thank you for purchasing TAKSTAR MX630 OTG USB Audio Interface. In order to better understand and use this product, we recommend you to read this manual carefully before use.

■ Introduction

MX630 OTG is a 4-in/4-out USB Audio Interface tailored for live streaming, internet karaoke and professional recording on PC and smartphone, distinguished by: 1) Use of ASIO2.0 driver that offers ultra-low latency; 2) High-precision sampling at 24bit/96KHz; 3) Support of various pro VST plugins; 4) Compatibility with Windows XP/Vista/7/8/10.

■ Features

- Tailored for network karaoke, professional recording, live streaming entertainment and e-commerce; compatible with Windows 10 or older.
- Driver is WHQL Certified to ensure stability and compatibility with Microsoft Windows systems.
- Adopts USB 2.0 standard for high-speed transmission and ultra-low latency.
- Supports high-precision sampling at 24bit/96KHz for clear recording and playback.
- Uses ASIO 2.0 driver standard; supports running more than two recording software simultaneously for webcast and professional recording.
- Powerful monitoring and recording functions; supports group live stream and chatting without stutter.
- Supports MME, WDM and DirectSound which enable sound signal transmission easily between the device and computer
- Volume controls for microphone, earphone and speaker outputs, as well as for cell phone recording.
- Equipped with two combo microphone/instrument input connectors.
- OTG function provides lossless recording and live broadcast for cell phones.
- Two $\Phi 6.3$ mm TRS balanced output L/R CH interface can be connected to active speakers.

■ Product Content

MX630 OTG USB Audio Interface.....	1PC
Audio Cable (Φ3mm*1.2m))	2PCS
Type-C Data Cable (Φ4mm*1.5m)	1PC
Power Adapter.....	1PC
3.5mm to 6.3mm Adapter.....	2PCS
User Manual.....	1PC

■ System Compatibility

USB interface compatible with Windows XP/Vista/7/8/10

Φ3.5mm connector compatible with iOS/Android

Minimum PC requirement: AMD/Intel 2-core CPU at 2GHz or above, 4GB RAM

■ Application

Network karaoke, professional recording, live streaming entertainment and e-commerce

■ Specification

MIC/LINE IN 1-2

Frequency Response: 20Hz-20KHz (± 1 dB)

Dynamic Range: 80dB (A-weighted)

S/N Ratio: 75dB (A-weighted)

THD + N: <0.025% (-72dB)

Intermodulation Distortion: -77dB @ 1KHz

Input Impedance: inst in, 6.8K Ω , typical

MIC IN: 6.8K Ω , typical

Adjustable Gain: >50dB

Gain Range: +54dB

HEADPHONE OUT 1-2

Frequency Response: 20Hz-20KHz (± 1 dB)

Dynamic Range: 99dB (A-weighted)

S/N Ratio: 103dB (A-weighted)

THD + N: <0.0056% (-85dB)

Intermodulation Distortion: -75dB @ 1KHz

Power: 90mW/100 Ω

Output Impedance: 75 Ω

Load Impedance: 32-600 Ω

Connector Specification

Cell Phone Connector: $\Phi 3.5$ mm

Accompaniment Connector: $\Phi 3.5$ mm

MIC Connector 1: XLR+ $\Phi 6.35$ mm

MIC Connector 2: XLR+ $\Phi 6.35$ mm

Headphone Connector 1: $\Phi 6.35$ mm

Headphone Connector 2: $\Phi 6.35$ mm

Speaker Connector: $\Phi 6.35$ mm (L+R)

Power Supply Connector: DC 12V $\overline{\text{---}}$ 1A

Data Connector: USB 2.0

OTG Port: Type-C

LINE/ACCOMPANIMENT IN 3-4

Frequency Response: 20Hz-20KHz (± 1 dB)
S/N Ratio: 100dB (A-weighted)
THD + N: <0.0031% (-90dB)
Dynamic Range: 97dB (A-weighted)
Max Input Level: +0dB, Gain: 0dB

LINE OUT L/R

Frequency Response: 20Hz-20KHz (± 1 dB)
Dynamic Range: 98dB (A-weighted)
S/N Ratio: 102dB (A-weighted)
THD + N: <0.0125% (-78 dB)
Intermodulation Distortion: -65dB @ 1KHz
Output Impedance: 75 Ω
Load Impedance: 32-600 Ω
Max Output Level: +1.2 dBV

General Specification

Data Transmission: USB2.0
Sample Rate: 44.1-96KHz/24bit
Power Supply: DC 12V $\overline{\text{---}}$ 1A (external power supply)
Operating Temperature Range: 0-40 $^{\circ}$ C
Dimension: 140*140*33.5mm(L*W*H)
Net Weight: approx. 465g

Note: the above data is measured by Takstar laboratory, and Takstar has the final interpretation right!

■ Function Description

Front Panel

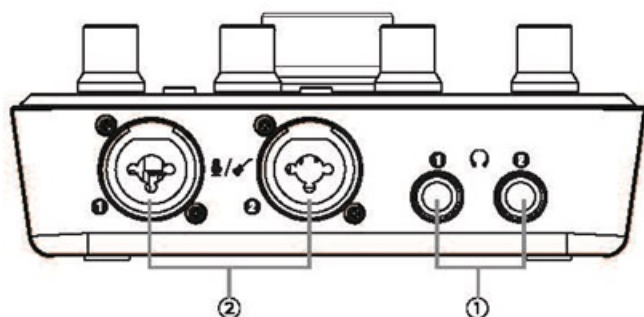

① Stereo Φ 6.35mm Headphone Connector ① / ②:

Used to connect with headphones. Each headphone output is driven by independent circuit, perfectly matching with Φ 6.35mm or adapting to Φ 3.5mm plugs.

② MIC/INSTRUMENT Connector ① / ②:

Used to connect with microphones or instruments such as guitars and electric pianos, with either XLR plugs or Φ 6.35mm plugs (balanced/unbalanced).

There are three types of input interface: bal XLR, bal TRS, and unbal TS.

Bal signal is preferred for it provides better noise rejection, especially when the cable is longer than 6m. When the connected equipment needs 48V phantom power, please use bal XLR.

The wiring standard, as designated by AES (Audio Engineering Society), is shown below:

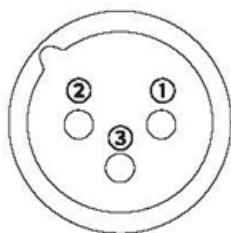

Polarity: ① Ground, ② Hot (+), ③ Cold (-)

Bal XLR

① Shield (Ground) Pin, ② Hot (+) Pin, ③ Cold (-) Pin

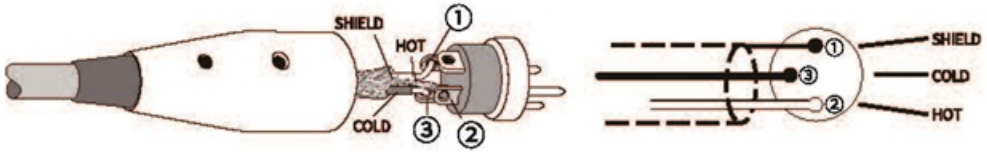

Bal XLR Connector

Bal TRS (Φ6.35mm)

Hot (+) Tip, Cold Ring, Shield Sleeve (Ground)

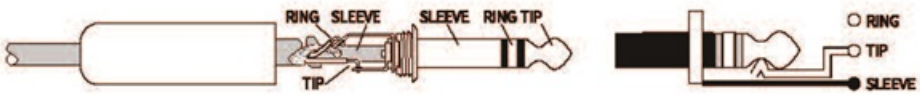

Bal TRS Connector

Unbal TS (Φ6.35mm)

Hot (+) Tip, Shield Sleeve

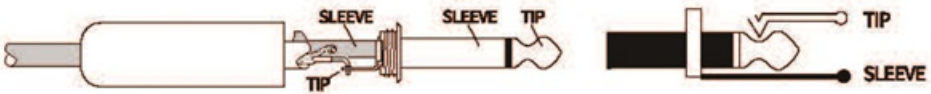

Unbal TS Connector

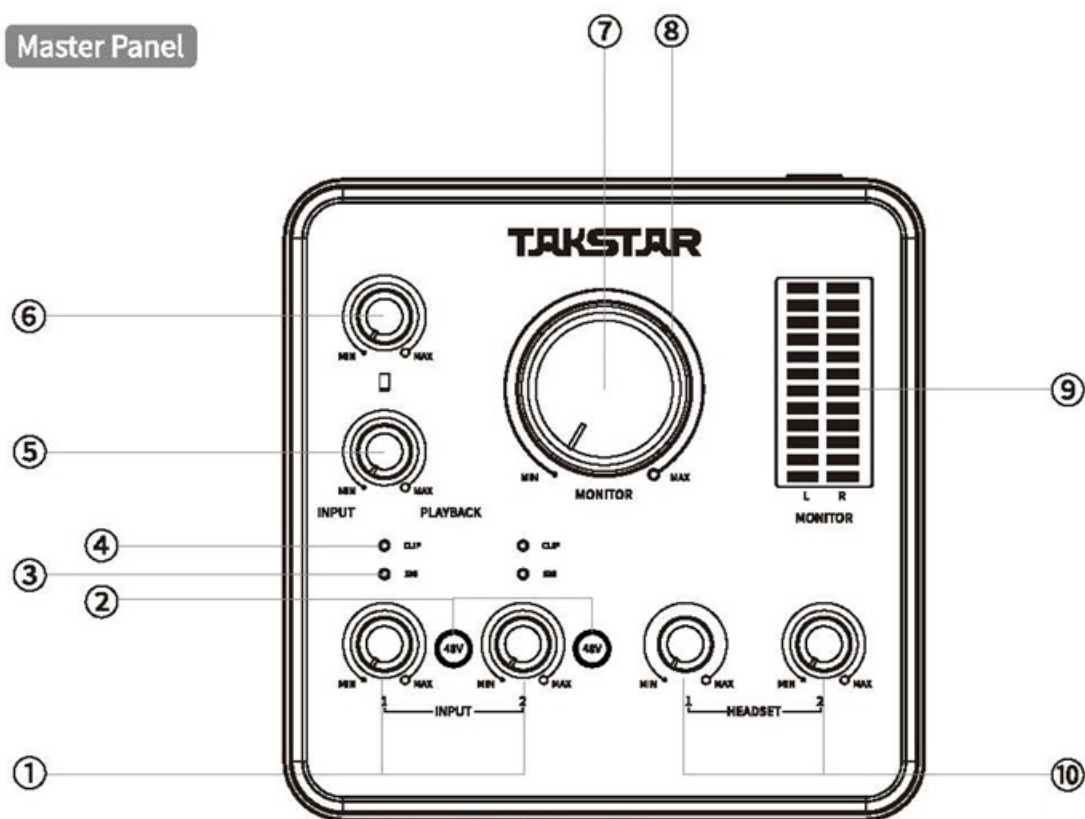
Master Panel

① INPUT 1 / 2 knob:

For adjusting the signal level of Input 1/2 respectively. Turn it counterclockwise to decrease the input signal level and vice versa.

- ② Long press to turn on/off the 48V phantom power.** When on, the button indicator lights up blue; when off, the button indicator goes off. Please turn off the phantom power when not needed, and do not connect or disconnect any equipment while the phantom power is on. When turning the phantom power on or off, turn all volumes to the minimum to prevent noise or damage to the equipment. Short press to mute/unmute the microphone. When muted, the button indicator lights up red; when unmuted, the button indicator returns to blue.

③ SIG LED:

For indicating whether there is signal input from MIC Connector 1/2. SIG LED lights up green when there is signal input detected, or goes off when none detected.

④ CLIP LED:

For indicating whether there is input signal clipping from MIC Connector 1/2. CLIP LED lights up red when there is signal clipping detected, or goes off when none detected.

⑤ Software/Hardware Monitor Knob:

For adjusting and balancing the sounds from software (accompaniment) and hardware (vocal). This knob affects only the volume of monitor headphone, but not the recording volume.

- (1) Turn it counterclockwise to turn the hardware sound up and the software sound down. Set it to **INPUT** position to directly monitor the hardware input sound.
- (2) Turn it clockwise to turn the software sound up and the hardware sound down. Set it to **PLAYBACK** position to directly monitor the sound from PC or software.

Take the example of recording audio novel or courseware with background music, where a microphone is connected to record vocal while music is played with Windows Media Player. Turn the knob counterclockwise to gradually increase the microphone volume and decrease the Windows Media Player volume, and vice versa. Turn to a certain position to find the best proportion between vocal and music. Turn to **INPUT** to minimize the background music monitor volume, or turn to **PLAYBACK** to minimize the microphone monitor volume.

⑥ Cell Phone Recording Volume Knob:

For adjusting volume output to the livestreaming cell phone (i.e., output volume to network). Turn the knob counterclockwise to decrease the volume heard by live stream audience, and vice versa.

⑦ Line Out (Speaker Out) Volume Knob:

For adjusting line out volume. Turn it counterclockwise to decrease the volume and vice versa.

⑧ Power LED:

When it is powered on, the LED lights up blue.

⑨ Output Signal LED:

For each L/R channel, there are 6 green LEDs, 3 yellow ones and 2 red ones, which change dynamically based on the signal level. When there is signal overload (clipping), the red LED lights up, in which case the microphone or accompaniment volume should be properly decreased.

⑩ Headphone Volume Knob:

For adjusting output volume level on **HEADPHONE ½** on front panel. Turn it counterclockwise to decrease the volume and vice versa.

Rear Panel

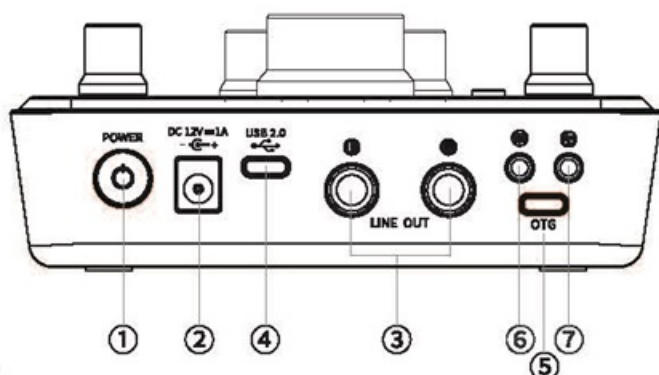

① Power Switch:

Press and hold for 2 seconds to turn on/off the device.

② Power Connector:

Connect adapter to provide power supply for the device. Please use the standard adapter. If it is not standard, please follow the specification requirement: DC 12V=1A, the outer ring of the connector is negative, and the internal is positive.

③ LINE OUT (SPEAKER OUT) L/R:

Connect (monitor or multimedia) speaker cabinet via $\Phi 6.35\text{mm}$ cable. It is compatible with $\Phi 6.35\text{mm}$ connector (bal/unbal).

There are two types of input available: bal TRS and unbal TS. Bal signal is preferred for it provides better noise rejection, especially when the cable is longer than 6m. The wiring standard, as designated by AES (Audio Engineering Society), is shown below:

Bal TRS ($\Phi 6.35\text{mm}$)

Hot (+) Tip

Cold Ring

Shield Sleeve (Ground)

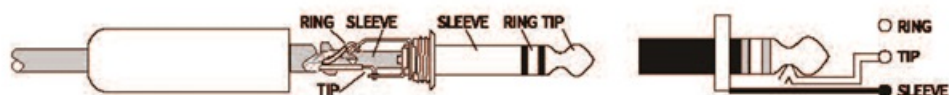

BAL TRS Connector

Unbal TS ($\Phi 6.35\text{mm}$)

Hot (+) tip

Shield sleeve

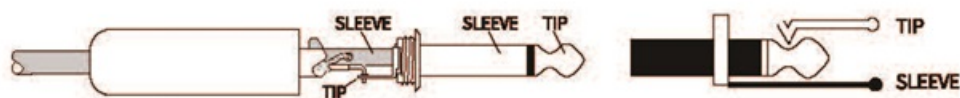

Unbal TS Connector

④ USB Port:

USB 2.0 standard for connecting to a computer. Make sure to connect via a high-quality USB cable (preferably the original USB cable supplied for the device) without USB extension cable or USB hub in between. When connecting to a USB 3.0 port, only USB 2.0 protocol will be used.

⑤ OTG Port:

Connect with a cell phone or tablet through OTG data cable to achieve lossless recording, live streaming and music appreciation. Please use a high quality OTG data cable (preferably the original OTG data cable supplied).

⑥ $\Phi 3.5\text{mm}$ Cell Phone Connector:

Connect to the cell phone via a $\Phi 3.5\text{mm}$ audio cable to transmit the audio signal from the device to the cell phone for livestreaming purpose.

■ Connection Diagram

Front Panel

Microphone Digital Instrument Guitar Headphone

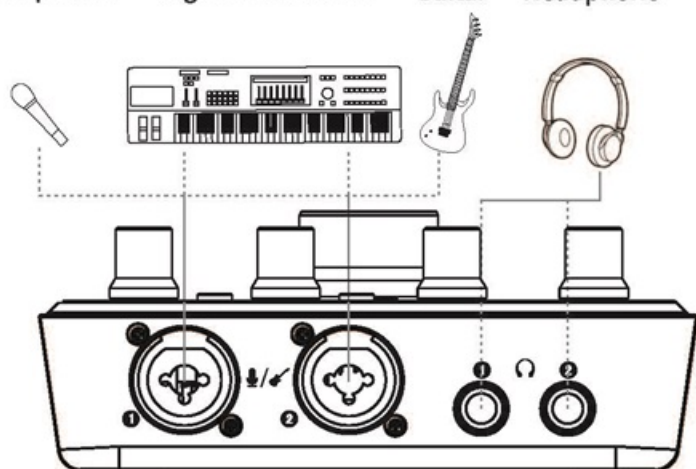

Rear Panel

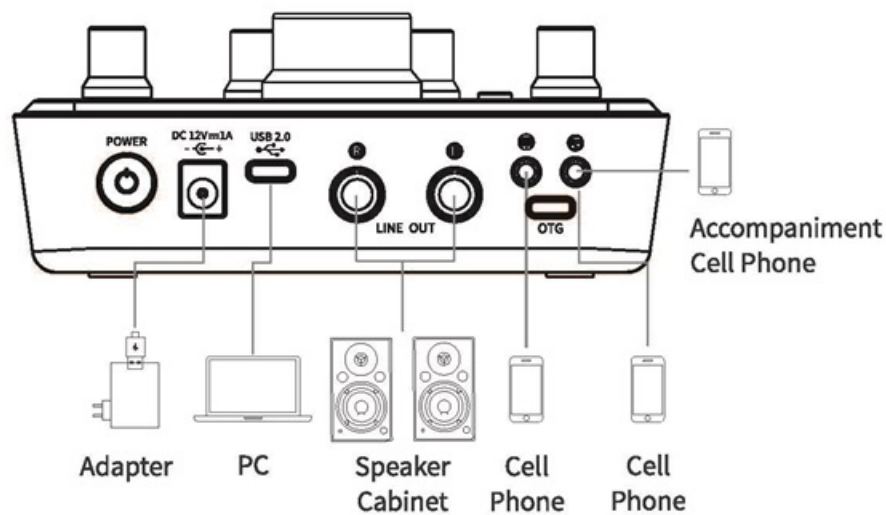

■ Driver Download and Installation

I. Driver Download

Drivers and firmware are constantly updated by us to ensure a better user experience. Please download the latest driver from Takstar official website at <https://www.takstar.com>.

Download Method 1: visit Takstar Official Website -> Service -> Download Center -> search “MX630OTG”, find and download “MX630OTG Driver”.

Download Method 2: visit Takstar Official Website -> search “MX630OTG” -> enter “MX630OTG” product page -> find and download “MX630OTG Driver” in “Download” tab.

Extract the downloaded file, then run “TAKSTAR_XY-S1Audio_x.x.x.setup” to install driver. For instructions about driver installation, uninstallation and upgrade, please refer to the “Operation Guide – MX630OTG” which can be obtained from the “Download” tab in the product page.

■ Driver Panel

A. Driver Icon:

Once the driver is installed, the MX630 OTG icon will appear in the system tray, as shown below. In case it is hidden, click the triangle icon in taskbar to configure.

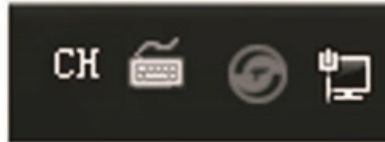

B. Device Setting:

Double click the driver icon to open the driver panel. Refer to the figure below:



1. USB Stream Mode:

Three options for USB stream mode: Minimum Latency, Low Latency, and Standard Mode.

- ① **Minimum Latency:** the input/output delay of the device is at minimum, and the monitor delay is less than 10ms (depending on buffer size). Please note that this option demands higher PC performance, and to prevent unwanted noise, please do not open other large software or process other tasks when using this mode in Windows 7/8.
- ② **Low Latency:** latency is higher than Minimum Latency, and the monitor delay is >20ms.
- ③ **Standard Mode:** relatively high latency, and the monitor delay is >30ms.

2. Sample Rate:

To set the current sample rate. There are four options: 44100, 48000, 88200 and 96000, available for various scenarios.

Whichever sample rate you choose, the audio driver will convert the sample rate to 44.1K and output it to stereo mix. This lowers the bandwidth usage on the network to help provide you a smooth livestreaming experience.

Wait at least 5s before recording or playing audio once the sample rate is modified for it to take effect. You can see if the modification is successful based on the current sample rate in the control panel status bar.

Note: due to Microsoft system limitations, modification of the sample rate on all WDM devices is achieved on driver level. Therefore, you cannot change the sample rate during playback or recording. Please change the sample rate after you exit the playing software and host software, as shown in the following

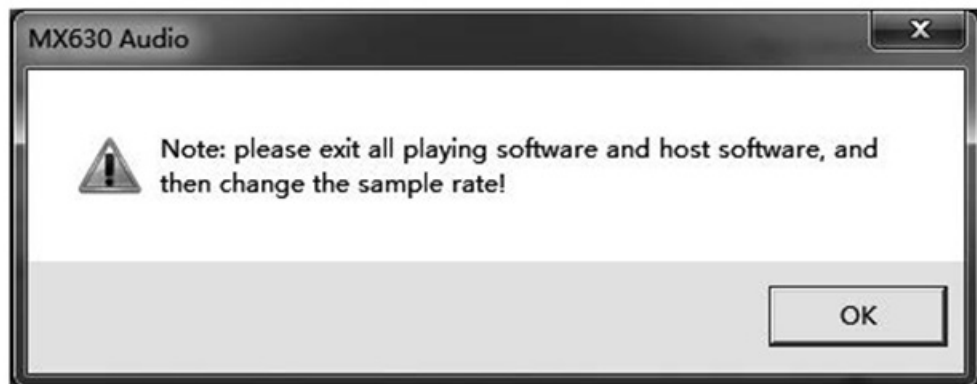

3. ASIO Buffer

ASIO buffer has five options: 64, 128, 256, 512, and 1024, available for various scenarios.

The buffer size can determine the Input/output data latency of ASIO and WDM, and might affect the system stability to certain extent. The audio input/output latency is shown in milliseconds. Audio delay varies based on the ASIO buffer size. The lower the ASIO buffer value, the lower the audio latency.

Principle for buffer selection: the smaller the buffer size, the lower the latency, and the easier the buffer loss. Select an optimal buffer size according to the performance of your computer. Selection of buffer size is also related to the sampling rate and stream mode. When the buffer size is too small for the current sampling rate and stream mode, the system will prompt you to increase the buffer size appropriately, as shown in the following figure:

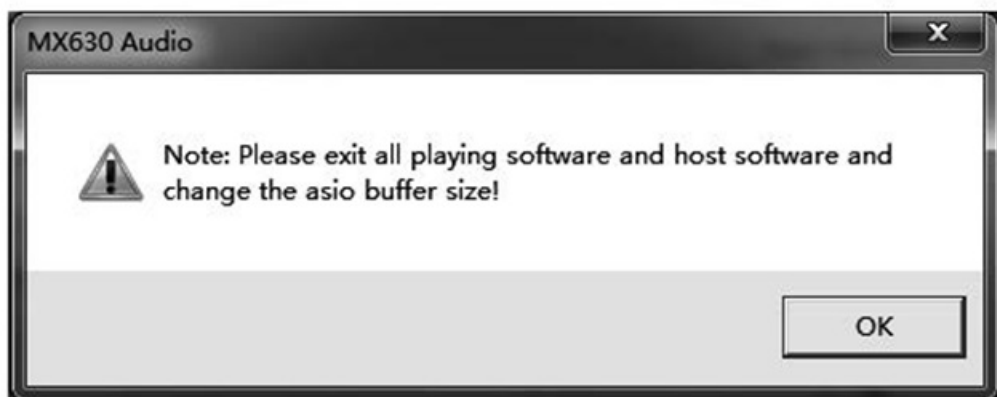

ASIO does not support asynchronous operation. This means that the input and output signals of ASIO will have to have the same sampling rate, otherwise it will cause audible and repeating noise.

4. Audio Quality

Audio quality selection: when the sampling rate is equal to or greater than 48K, this option will be in effect to determine the re-sampling audio quality from system speaker.

5. Using MMCSS Services

This function can activate higher priority for ASIO driver. Note: currently only the latest version of CUBASE / NUENDO can support activation of this function under high load. Enabling this for other software will reduce performance. Changes will take effect after restarting ASIO, helping you find the best setting quickly. It is on by default. When the basic process priority of VST software is "real-time", it is suggested to turn off MMCSS to prevent priority inversion which will cause instability issues.

■ Playback Setting Description

MX630 OTG supports ASIO direct monitoring, but it should be noted that not all programs fully support direct monitoring, which will affect the compatibility of ADM. MX630 OTG supports MME, WDM and DirectSound, and which one is better depends on the application used.

In the audio playback software used, MX630 OTG must be set as the output device. Generally speaking, such settings can be found in the settings of the playback software under playback device or audio device.

Take the system built-in player, Windows Media Player (WMP), as an example. Select an audio device in the "Devices" -> "Speaker Properties" dialog, to output the audio data to the corresponding virtual output device (for sound playback).

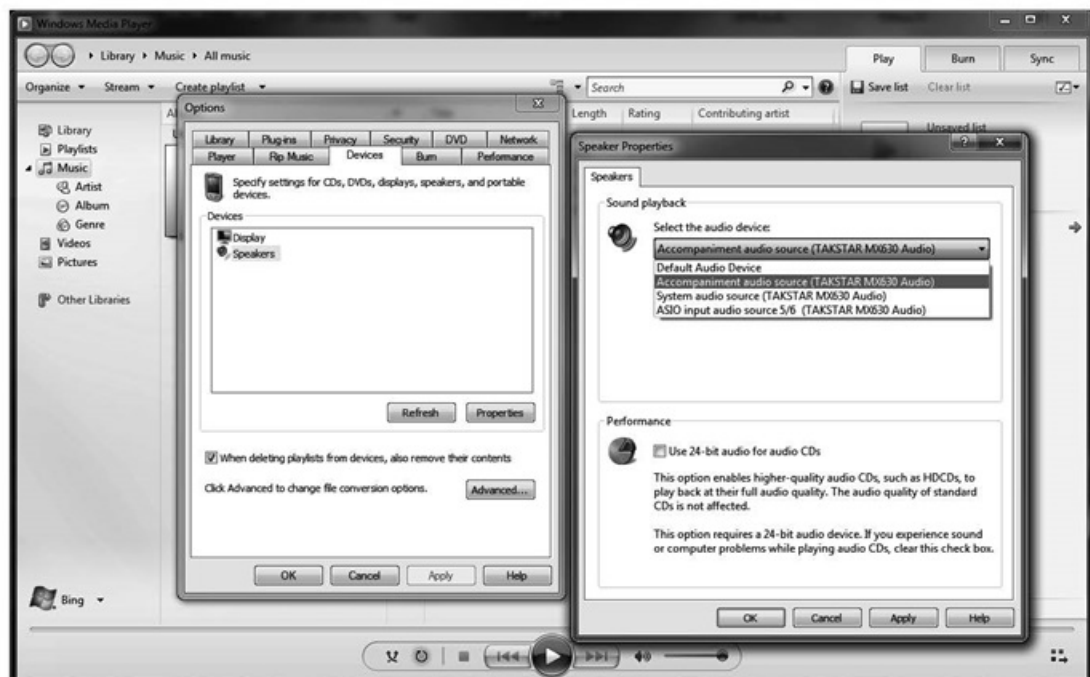

- ① When "ASIO Input Sound Source 5/6" is selected as the audio output device, the audio data will be output to the VST software. Select the corresponding audio channel in the input device of the VST software, then the music played will be introduced into the software;
- ② When the "Accompaniment Audio Source" is selected as the audio output device, the music played by WMP will be sent to the network, to be heard by the audiences watching your live stream or in various chatting platforms.
- ③ When "System Audio Source" is selected as the audio output device, the music played by WMP will only be output for monitoring and will not be transmitted to the network terminal.

■ Multiple Apps Support

MX630 OTG supports multi-terminal operation, which means that multiple applications can run at the same time, using multiple WDM and ASIO inputs, and ASIO and WDM formats can even be used simultaneously in the same playback channel.

However, because WDM uses real-time sample rate conversion (ASIO cannot), all active ASIO VST software can only use the same sample rate.

■ System Audio Setting

1. System Audio Source:

In "System Audio Source TAKSTAR MX630 OTG Audio" channel, the sound outputs directly without going through the recording mixer, such as the system prompt sound, the web page sound and the default software output sound. If selected, audiences over the internet chat room or live broadcast will not be able to hear the music played in your playback software but yourself.

2. Accompaniment Audio Source:

In "Accompaniment Audio Source TAKSTAR MX630 OTG Audio" channel, the sound played by the computer is transmitted to the network terminal, that is, during network chatting or live broadcast, you and the audience can both hear the computer playback sound.

3. ASIO Input Sound Source 5/6:

In "ASIO Input Audio Source 5/6 TAKSTAR MX630 OTG Audio" channel, the music output by playback software passes through the VST software before it outputs to the network terminal. If you don't open the software, you can't hear the music played by the playback software.

Once the ASIO driver is installed, the "System Audio Source TAKSTAR MX630 OTG Audio" device will be automatically set as the default playback device, and the "Stereo Mix TAKSTAR MX630 OTG Audio" device be set as the default recording device, as shown in the following figure:

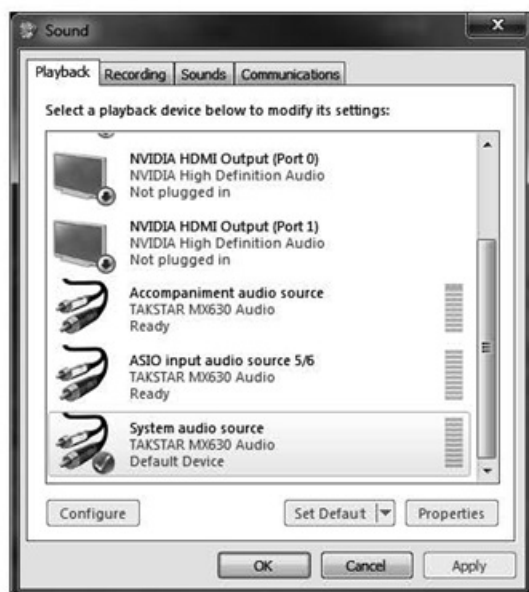

Take Windows 7 as an example. Open the "Playback Device" option via the system speaker icon to view the current playback device. In the Levels tab of the playback device dialog, you can adjust the volume of the relevant playback device, as shown in the following figure:



The output volume of relevant playback devices can also be adjusted by opening "Volume Mixer" via the system speaker icon, as shown in the following figure:

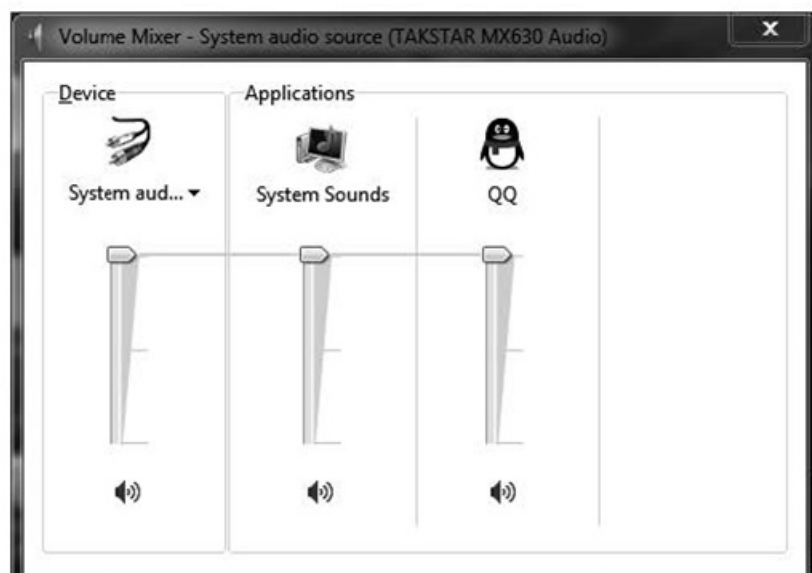

■ Recording Application

When recording through recording software, the corresponding recording device, MX630 OTG Analog (x + y) or MX630 OTG Virtual (x + y), must be selected.

First, connect the device according to the connection diagram, and then install the driver (for specific driver installation steps, please refer to the "Operation Guide", which can be found on the product details page in our official website: www.takstar.com).

Taking CUBASE as an example, select "TAKSTAR MX630 OTG ASIO Driver" as the default recording device under VST Audio System in ASIO Driver settings, as shown in the following figure:

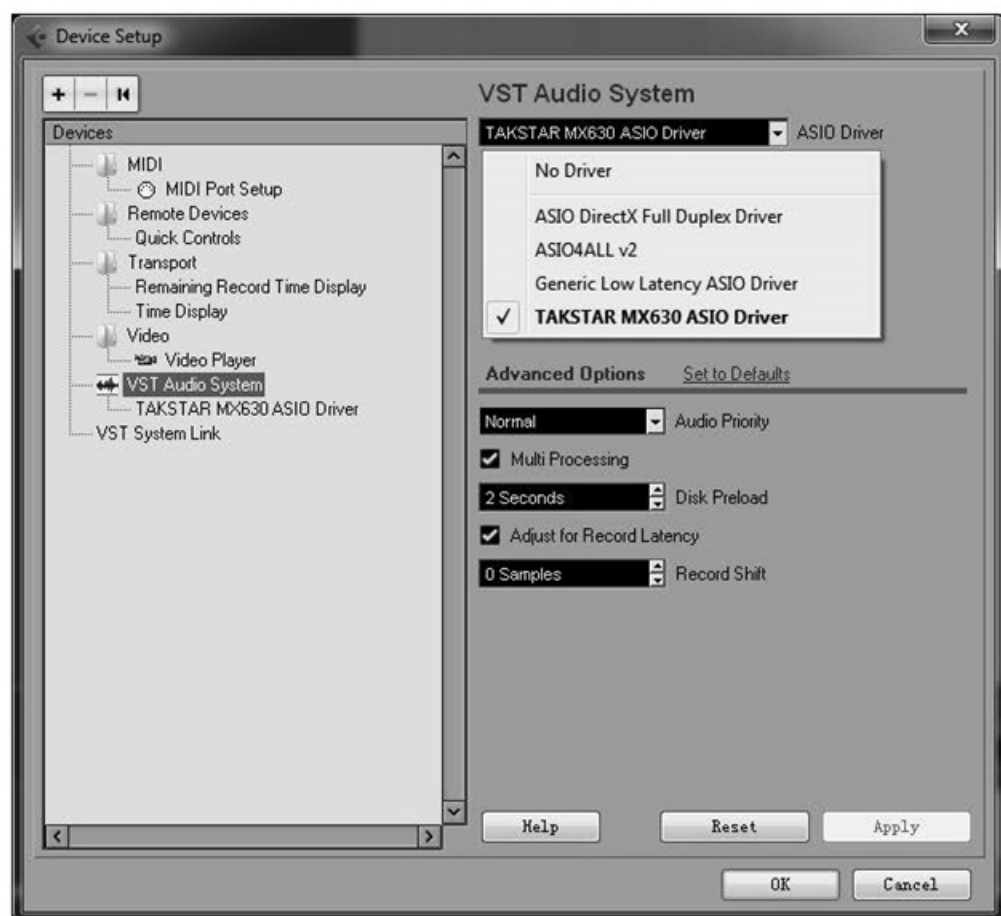

Select the corresponding input device at the device port of different recording tracks. When MX630 analog input (1 + 2) is selected, 1 / 2 channel signal is input from microphone. When mx630 analog input (3 + 4) is selected, corresponding sound card accompaniment input interface signal is corresponding. When MX630 virtual input (5 + 6) is selected, ASIO input sound source 5 / 6 signal of corresponding player will be introduced into the software. The port names of different recording software devices are different, and the actual recording software shall prevail, as shown in the figure below:

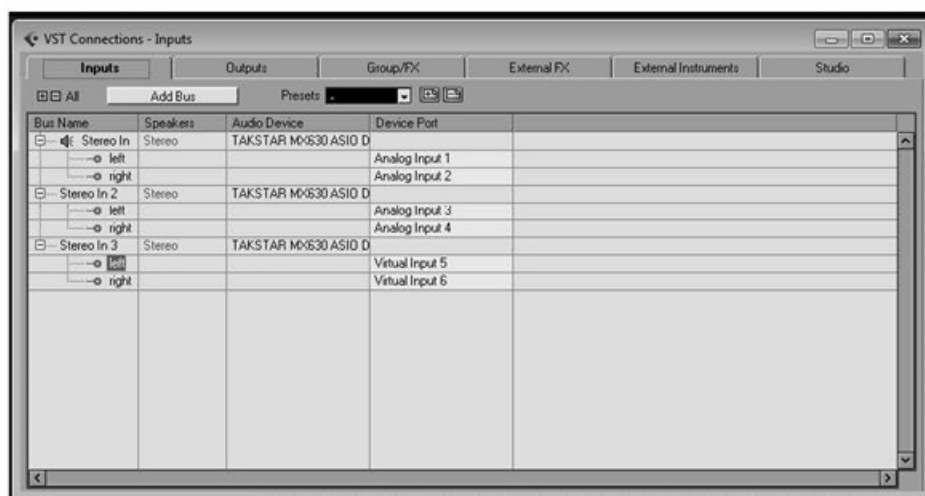

Select the corresponding output device at the Device Ports of different recording tracks. MX630 OTG Analog Output (1+2) corresponds to (Speaker) Output L / R and Headphone Output 1/2, as shown in the figure below.

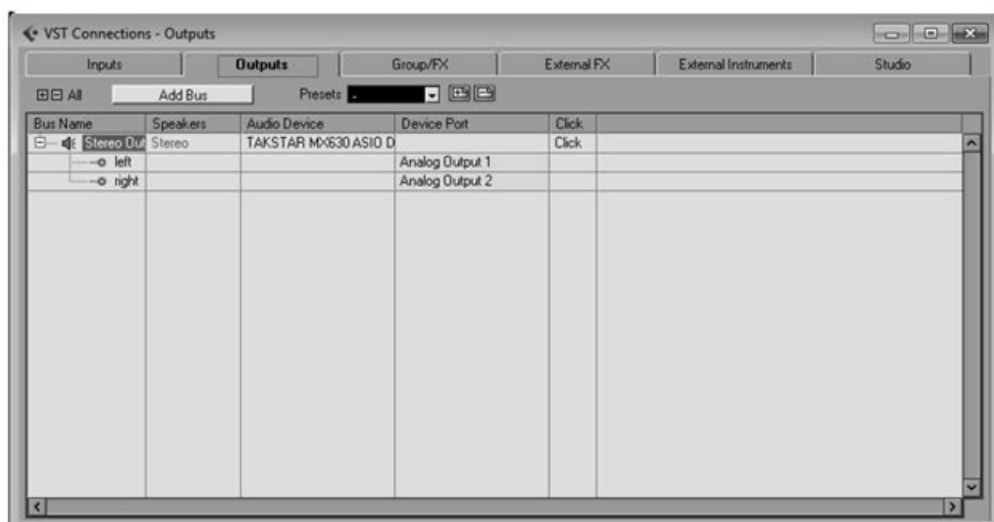

For more information about recording instructions, please refer to the guidebook for the recording software or visit its official website.

■ Webcast Application

Refer to the connection diagram. After the device is installed and connected, turn the hardware and software monitoring knob to the "PLAYBACK" direction, open the playback software, such as Windows Media Player, and select "Accompaniment Audio Source" as the output audio device. Set the VST settings and VST plug-in effects (requires a background knowledge in audio mixing for proper tuning methods and techniques) in reference to the Recording Application section. Then open the corresponding live broadcast platform on the computer or cell phone terminal to start synchronous live streaming on both devices.

■ OTG Function

MX630 OTG can be directly connected with iPad or iPhone via USB for recording, live broadcasting and music appreciation.

There may be compatibility issues if your iOS version is too low. In newer versions of iOS, the device name will be displayed after connection. However, if the device is incompatible with the connected iPad or iPhone, the iPad or iPhone will prompt a message "This accessory may not be supported".

Therefore, we strongly recommend purchasing the original Apple data cable. Meanwhile, please remove the protective case for iPad or iPhone if it prevents tight and secure connection with the cable.

Tip: MX630 OTG function is also compatible with some Android phones and tablets. But due to the wide variety of Android brand and version on the market, the specific compatible models are not listed here and should be subject to the actual application. Please feel free to test it.

■ Troubleshooting

A. Cannot power on device

Make sure that the device is connected to the power supply through the adapter.

B. Device is not recognized by computer

1. Make sure that the USB cable is properly connected without any damage on it.
Try using a new functioning USB cable, preferably one less than 3m long.
2. The USB port is not activated in the system (please check the "Device Manager" in Windows system).
3. The USB cable is not fully plugged in or is in a wrong interface.
4. The device is not connected to the power supply.
5. Driver is not installed properly.

C. No sound

1. Check if the device volume knob is turned too low; try adjusting it back to normal level.
2. Check if the playback software is playing normally; try closing and re-starting it.
3. Check if the audio device is disabled.
4. If either the software or hardware sound is missing, check if the software/hardware monitor knob is turned to INPUT or PLAYBACK position. Try adjusting it and see if the sound is back.
5. Check if the microphone and speaker is properly connected to the device in accordance with the connection diagram.
6. If using a 48V power supply condenser microphone, please check whether the "48V" switch indicator is on.
7. Check if the headphone is connected properly; try unplugging and re-plugging in.
8. Check if the audio device is selected as the current device. Please refer to instructions on system audio settings and selection on playback software audio device.
9. Check if there are other USB devices connected to the computer; try unplugging them to see if the sound is back to normal.
10. Check if there are any conflicting programs running; try closing them to see if the sound is back to normal.

D. Abnormal sound (noise, intermittent sound, distortion)

1. Check if the ASIO buffer size is set too low. Refer to the ASIO Buffer section in this manual for size recommendation. Try increasing the ASIO buffer to see if the sound is back to normal.
2. Check if long continuous audio is being recorded or played. The computer's audio data processing capability depends on many factors including CPU speed and access to external devices. Try reducing the sound tracks and check again.
3. Insufficient power supply to CPU or insufficient transmission speed in USB Bus is known to cause pop noises. To prevent this, increase the buffer size in the ASIO control panel of the device.

■ Safety Instructions

To avoid electric shock, overheat, fire, radiation, explosion, mechanical risk and injury or property loss due to improper use, please read and observe the following instructions before use:

1. Please check if the power of the connected equipment matches with that of this product before operation. Adjust the volume to proper level during operation. Do not operate at over-power or high-volume level for extended time to avoid product malfunction or hearing impairment.
2. If there is any abnormality during use (e.g., smoke, strange odor), please kill the power switch and unplug from power source, then send the product to the local dealer for repair.
3. Keep this device and its accessories in a dry and ventilated area. Do not store in a humid or dusty area for extended time. Keep away from fire, rain, liquid intrusion, bumping, throwing, vibrating, or from blocking any ventilation openings, to prevent malfunction.
4. Unplug from power source before cleaning the device. Clean with a dry soft cloth. Do not use any thinner, solvent or cleaning agent.

5. Unplug the device during lightning storms or when unused for long periods of time.
6. Do not overload the wall socket or extension cord, or else it may cause fire or electric shock.
7. Protect the power cord from being stepped on or squeezed, especially at the plug, socket, and their joints with the cable.
8. Please abide by safety rules during operation. Do not use the product in places prohibited by laws or regulations to avoid accident.
9. Please use accessories designated by the manufacturer.
10. Do not disassemble or repair the product by yourself to avoid injury. If you have any questions or require any services, please contact our local dealer.
Unauthorized disassembly or repair may void your warranty.
11. Please use the furnished power adapter for power supply if one is required. Any third-party adapter used should be CCC certified and comply with the device power specification.
12. The applicable altitude and climate conditions for the device are subject to those described on the power adapter. For example:



Suitable only for
altitudes below 2,000m



Suitable only for non-tropical
climates

■ Label Meanings



According to the test results obtained based on RL2004/108/EG (Electromagnetic Compatibility Directive) and RL2006/95/EG (Low Voltage Directive), this product complies with the limits specified in the European Community EMC (Electromagnetic Compatibility) Directive, an integration of relevant laws from its member states.



This symbol indicates that, according to WEEE (Waste of Electrical and Electronic Equipment) Directive (2012/19/EU) and national laws, this type of waste should not be discarded along with your household waste, as it contains potentially hazardous substances that may pose a negative impact on the environment and human health. It should be handed over to an authorized WEEE collection facility for recovery and recycle. By doing so, you will be helping effective utilization of natural resources. For more information about where you can dispose WEEE products, please contact your local municipal office, waste management bureau or household waste disposal service.



Note: This equipment has been tested and found to comply with the limits for a Class B digital device, pursuant to part 15 of the FCC Rules.

These limits are designed to provide reasonable protection against harmful interference in a residential installation. This equipment generates, uses, and can radiate radio frequency energy and, if not installed and used in accordance with the instructions, may cause harmful interference to radio communications. However, there is no guarantee that interference will not occur in a particular installation.

If this equipment does cause harmful interference to radio or television reception, which can be determined by turning the equipment off and on, the user is encouraged to try to correct the interference by one or more of the following measures:

- Reorient or relocate the receiving antenna.
- Increase the separation between the equipment and receiver.
- Connect the equipment to an outlet on a circuit different from that to which the receiver is connected.
- Consult the dealer or an experienced radio/TV technician for help.

Changes or modifications not expressly approved by the complying party may cause the user to lose permission to operate the device.

This device complies with part 15 of the FCC Rules. Operation is subject to the following two conditions:

- 1) This device may not cause harmful interference, and
- 2) This device must accept any interference received, including interference that may cause undesired operation.



This icon indicates that the product has passed "WHQL Microsoft Logo Certification", that is, "Microsoft operating system hardware quality laboratory certification". WHQL certification is a benchmark certification system introduced by Microsoft to ensure the stability and compatibility of the system. WHQL certified products can achieve better compatibility, stability and interoperability with Windows operating system, and eliminate system or device downtime and performance degradation, providing a better user experience. Microsoft stipulates that all products certified by WHQL will be awarded the "Windows Compatible Logo", and the relevant information will appear in the official Microsoft website and the Hardware Compatibility List (HCL) of the operating system for easy query. WHQL certified driver will not receive a compatibility pop-up warning during installation, because the device driver is included in Microsoft's HCL and is digitally signed and approved. This means that users can put their trust in the device as their operating systems are less likely to be affected by unstable and poor-performance drivers and software.



Suitable only for indoor applications.



Supplied adapter is 3C-Compliant (China Compulsory Certification).



Class II electrical appliance with double insulation.

■ About This Manual

This manual contains up-to-date technical specifications as of printing. However, this manual may not contain specifications conforming to your particular product since Takstar is constantly improving its products. For the latest version/more information, please visit our website: <https://www.takstar.com/>.

Specifications, devices or accessories available may vary from region to region. If you have any questions, please contact our local dealer.

注意事项:

1. 本单为保修凭证, 请用户妥善保管, 如有遗失, 恕不保修或退换。
2. 保修期限制: 购买之日起十二个月内。
3. 除了不可抗力事件损坏外, 由本公司负责, 免费维修。
4. 如属保管不善或使用不当造成的损坏, 维修点将酌情收费。
5. 擅自拆卸维修者, 不予保修。
6. 以上保修条款仅限于中国市场适用 (不含港澳台地区)。

产品服务保证书

姓名: _____ 电话: _____ 地址: _____

商品: _____ 型号: _____ 购买日期: _____ 年 _____ 月 _____ 日

维修记录栏 (由维修员填写)	维修员签名	日期

◆ 广东得胜电子有限公司 ◆ 电话: 400-6828-333 ◆ 地址: 广东省惠州市博罗县龙溪街道言康一路2号



扫一扫，了解更多产品
Scan for more
product information

**广东省电声工程技术研究开发中心
广东得胜电子有限公司制造**

地址: 广东省惠州市博罗县龙溪街道富康一路2号

Designed & Manufactured by:

Guangdong Takstar Electronic Co., Ltd.
Address: No.2 Fu Kang Yi Rd., Longxi Boluo
Huizhou,Guangdong 516121 China

GB/T 12060.3-2011
GB 8898-2011
9T60TGS1A